

since  
1946

talleres  
trepas

hinges and  
paumelles



**Justor**



VINCA  
INDUSTRIAL

5 Tm

# index

**Justor**

## 1 | introduction

- PP-
  - 8 who are we
  - 12 solutions
  - 14 common considerations

## 3 | single action

### SA series

- AL
  - PP-
    - 34 SA 120 / 180
- SST
  - 36 SA 120 / 180
- IRON
  - 38 SA 120 / 180

### ST series

- AL
  - PP-
    - 40 STW 150 / STC 150
- SST
  - 42 STW 150 / STC 150

### SF series

- AL
  - PP-
    - 44 SF 120

## 5 | data sheet

- PP-
  - 66 overview
  - 68 DA / DP
  - 70 SA / ST / SF
  - 72 MB / MP / PM / PF / MZ
  - 73 PG / PP

## 2 | double action

### DA series

- AL
  - PP-
    - 20 DA 120 / 180
    - 22 DAW 120 / 180
    - 24 DA R40 180
- SST
  - 26 DA 120 / 180
- IRON
  - 28 DA 120 / 180

### DP series

- AL
  - PP-
    - 30 DP 120

## 4 | spring hinge

- AL
  - PP-
    - 48 MB
    - 50 MP
    - 52 PM
    - 54 PF
    - 56 MZ
- SST / IRON
  - 58 PG washer
    - 120/180/240
  - 60 PG bearing
    - 180CR/240CR/240CRP
- IRON
  - 62 PP

## 6 | codes

- PP-
  - 76 - 77 DA / DP
  - 77 - 78 SA / ST / SF
  - 78 - 79 MB / MP / PM / PF / MZ
  - 79 PG / PP



A company formed by a team  
whose mission is to manufacture  
all **Justor** products with the  
highest quality and warranty







# Objective: quality assurance, prestige and brand pride

The **Justor** spring hinges are fittings designed to ensure smooth automatic closing of all types of doors, windows, covers, etc.

Designed in **aluminum, stainless steel, iron and/or plastic**, our wide range of products offers solutions for single acting doors as well as double acting doors (swing doors).

With a distinguished **spring system** consisting of a set of **blades** working by torsion, lifetime of these products can reach up to 500.000 opening and closing cycles. The strength of the spring is always adjustable and the loading capacity of these products can be up to 250kg, depending on chosen product and finishing.



## Solutions for all types of doors

12

Manufacturers since 1946, our spring hinges are sold in over 70 countries. The reason for this success is that we meet the **different needs** demanded in such diverse industries as metal, wood, food, health, aeronautics, etc. and in all types of indoor and outdoor architecture projecting today.



**Justor**

# Common considerations for all hinges

## aluminum



silver .01



gold .02



bronze .03



white .06

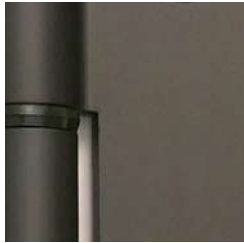

black .09



F6 finishing .94



bright brass .04

**All our hinges are available with and without spring.**

**All our models can be produced in any RAL color as required.**

## stainless steel



sst AISI 304 .05



sst AISI 316 .35

## iron



zinc-plated iron .08

### proper installation of 2 and 3 hinges

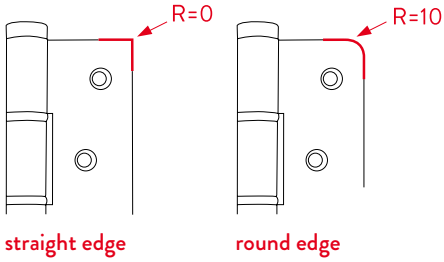
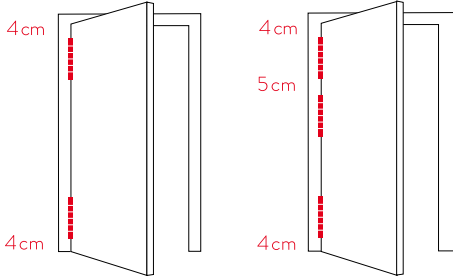

### packaging



### maintenance

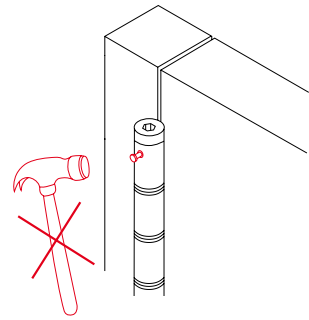
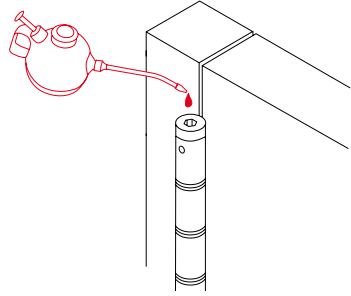

### tension

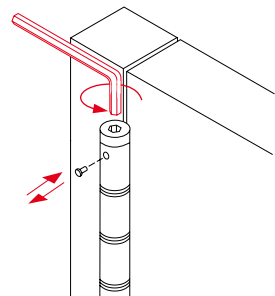

### cap

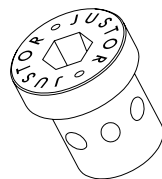

# Common considerations for all hinges

## spring system

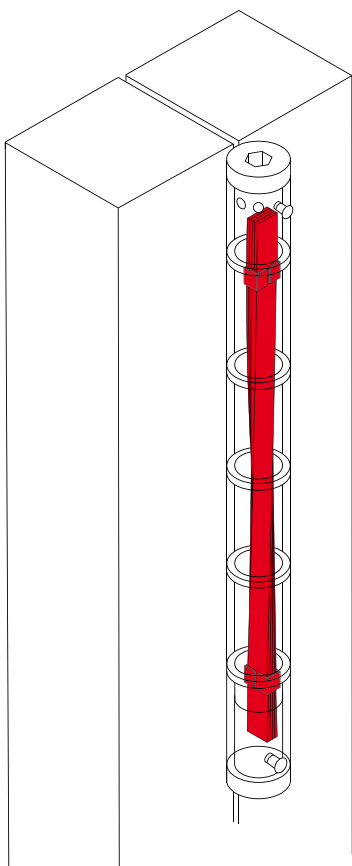

Our spring system is composed of a set of blades that works by torsion and underlies the high performance of our spring hinges.

Either **iron** or **stainless steel**, the quality of material used in its manufacturing, its high resistance to breakage and deformation and its optimum elasticity makes a big difference on the market between a **Justor** spring hinge and a normal spring hinge.

Until today there isn't an equal spring system used to assemble spring hinges, this is a very important fact because this element is what really determines the door weight capacity, as well as the opening/closing cycles, namely, the lifetime cycles of the product.



easy adjustment

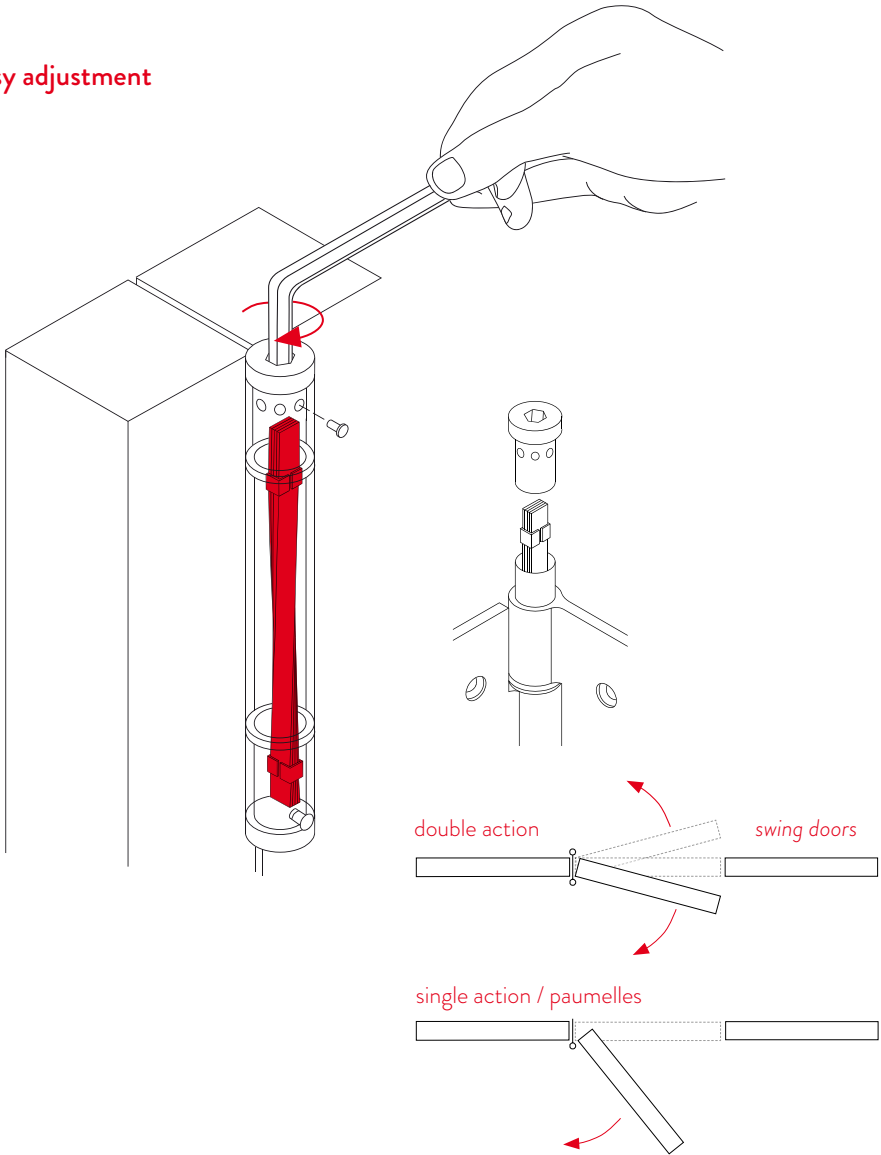

# double action

for swing doors

**Justor**

## DA series

### AL

PP-

- 20 DA 120 DA 180
  - 22 DAW 120 DAW 180
  - 24 DA R40 180
- The widest range for the aluminum and wood professional.

### SST

PP-

- 26 DA 120 DA 180
- Prepared for the most demanding situations, offering a high resistance to intensive use.

### IRON

PP-

- 28 DA 120 DA 180
- New applications to give solutions in new markets.

## DP series

### AL

PP-

- 30 DP 120
- A unique and surprising innovation for light double action doors.

aluminum

double action  
DA series

DA 120  
DA 180





DA double action

## DA 120 DA 180

Hinges for swing doors, conceived for a lot of transit. Available in 3 different widths, 30mm, 40mm and 50mm (only DA 180), they provide a solution to any need.



### Uses

Clinic and hospital doors, industrial and design kitchens, interior entries to warehouses and shops in general.

### Features

For wooden and aluminum doors. Spring resistance 500.000 opening and closing cycles. Available in silver, gold, bronze, white and black. Possibility of manufacturing in other colors. Finishings with straight edge (90°) and round edge (R=10).

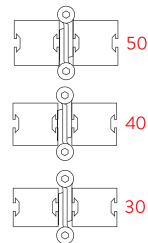
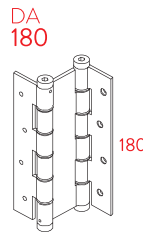
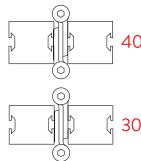
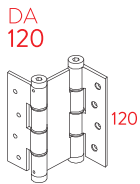

aluminum

double action  
DA series

DAW 120  
DAW 180

22







DA double action

## DAW 120 DAW 180

Hinge designed for direct mounting on frame or wall, without milling or rebating. **It reduces up to 50% assembly time compared to a conventional spring hinge.**



### Uses

Especially suitable in applications for woodwork in restoration and interior architecture.

### Features

Exclusively available in anodized aluminum, finishing in various colors. High resistant polyamide washers, zamak chrome or black cap (depending on model) and galvanized steel pins. Adjustable closing power and high loading capacity. More than 500.000 lifecycles.

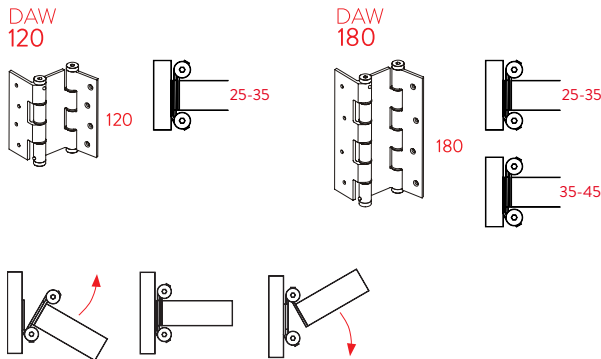

aluminum

double action  
DA series

DA R40 180

24





DA double action

# DA R40 180

Specifically made for the aluminium market, this hinge adapts perfectly to all kinds of swing doors with R40 profile. This is possible thanks to the specific design of each of its blades, which facilitates its fitting within the profile itself, achieving an almost perfect functioning.

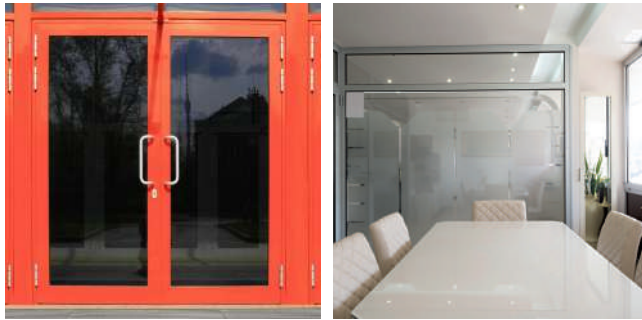

### Uses

Sports facilities, exhibition centers, pharmaceutical laboratories and spray booths.

### Features

3-points of force intensity, easily adjustable. Optimal work efficiency with 2 hinges assemblies, as well as 3 hinges installations. Load capacity up to 65kg.

DA R40  
180

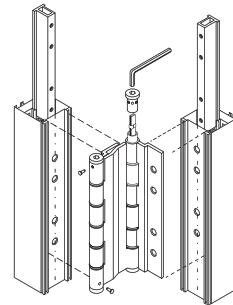
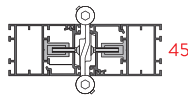
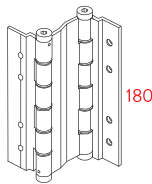

stainless steel

double action  
DA series

DA 120  
DA 180

26





DA double action

## DA 120 DA 180

Prepared to work in especially harsh environments. Available in stainless steel **AISI 304** and **AISI 316** stainless steel, better known as “Marine Steel”.



### Uses

Coastal facilities, nautical industry, saline environments, food industry and livestock sector among others.

### Features

Polished stainless steel, sintered caps and washers **AISI 316**, pins and inner shaft **AISI 304**. Stainless steel inside leaf spring **AISI 301**, covered with corrosion protective grease, especially suitable for marine environments.

DA  
120

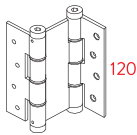

DA  
180

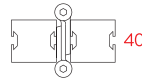
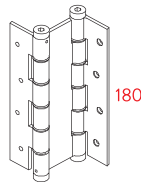





IRON

DA double action

## DA 120 DA 180

Hinge prepared for traditional installation to be fixed with screws, as well as for installation by welding on frame and door.



### Uses

Accesses to transport machinery, internal factories passages and metal industry in general.

### Features

Finish in galvanized steel. Force adjustment with pin. Maximum performance even with minimum tension. Capacity up to 20kg per hinge (see application table).

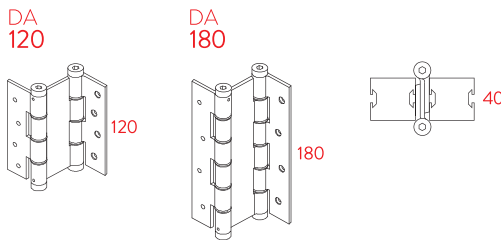



AL

DA double action

## DP 120

Double action spring hinge for swinging doors. Easy and fast installation. It is installed directly without milling frame or door.



### Uses

Light doors to access pharmacy counters, bars or other food and catering stores.

### Features

It allows to dismantle the door without having to unscrew the pin. Just 2.5mm thick. Load capacity of up to 20kg. Double action spring hinge 120mm length, 3 possible tension points of the inner spring. Available in aluminum in silver, gold, bronze, white and black finish.

DP  
120

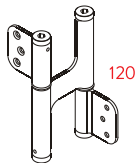

120

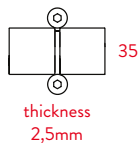

35

thickness  
2,5mm

# single action

**Justor**

## SA series

AL

PP-

34 SA 120  
SA 180

Made from lightweight quality materials, high load capacity guaranteed.

SST

PP-

36 SA 120  
SA 180

Different qualities to satisfy every need.

IRON

PP-

38 SA 120  
SA 180

Solutions in new materials for new applications.

## SF series

AL

PP-

44 SF 120

Same quality, redesigned for new applications.

## ST series

AL

PP-

40 STW 150  
STC 150

A new concept for spring hinges, installation without mortising.

SST

PP-

42 STW 150  
STW 150

Prepared for outdoor installations, presenting a compact and innovative design.

aluminum

single action  
SA series

SA 120  
SA 180

34





SA single action

# SA 120 SA 180

Hinge for wooden and aluminum doors. Closing strength adjustable with multipoint cap.



### Uses

Suitable for entries requiring immediate closing, especially when it isn't possible to install a traditional hydraulic door closer.

### Features

Made of anodized aluminum. Four fixation points on each blade. Finishing with straight edge or round edge. Can be manufactured in any RAL colors on demand.

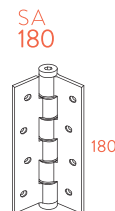
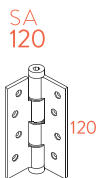





SST

SA single action

## SA 120 SA 180

Specially prepared for outdoor use, in damp and/or saline environment. Shaft protected with anti corrosion grease. Allows door opening to 180°.



### Uses

Hotel rooms, locker rooms, accesses to boat docks, facilities in chemical and pharmaceutical industry as well as any type of marine environment.

### Features

Hinge made of stainless steel AISI 304 or stainless steel AISI 316. Polish treatment. Sintered caps and washers, always in stainless AISI 316.

SA 120

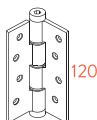

SA 180

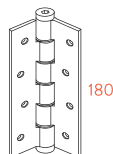





SA single action

## SA 120 SA 180

It allows installation by welding providing the same performance as by fixing with screws. The steel hinges provide the same work performance as the aluminum or stainless steel hinges.



### Uses

Pedestrian accesses, private homes, boiler works, external fencing, metal constructions, forge works.

### Features

Galvanized Steel. Easy strength adjustment. High load capacity. 3mm thick blades. Minimum of 250.000 working cycles.

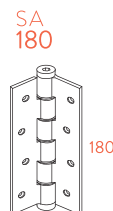
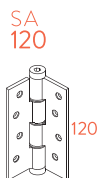



aluminum

single action  
ST series

STW 150  
STC 150

40





ST series

## STW STC 150 150

Hinges with a special design, where the blade works inside the other blade, providing exceptional thinness, no need to rebate.



### Uses

Any type of light interior doors like offices, archives, cabinets...

### Features

In the STW version, the blades are displaced from the axis of the hinges, allowing direct installation to any surface without sub frame.

STC version has two different blade lengths, providing solutions to existing frameworks in different thicknesses.

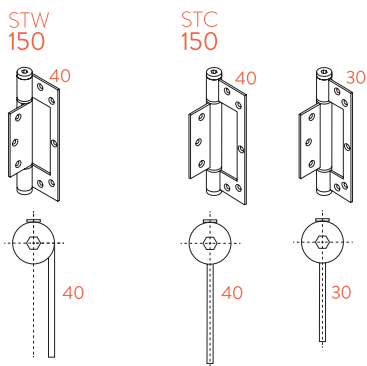

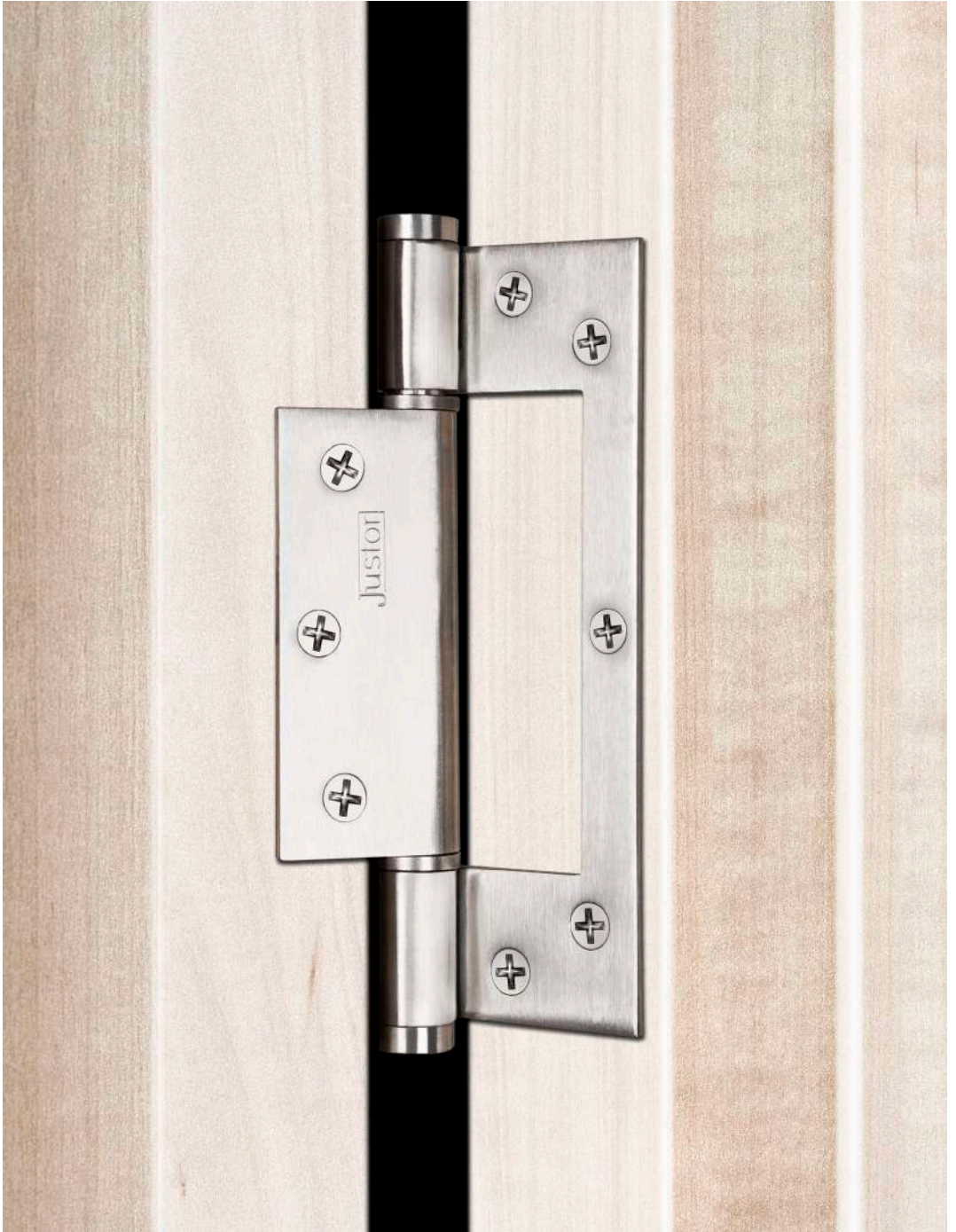



SST

ST series

## STW STC 150 150

Hinge with the rotation axis displaced. Just 2,5mm thick.  
Respects the natural space between frame and door.  
Reduces assembly time since it can be installed directly  
without milling frame or door.



### Uses

Interior design, sports facilities, health centers and food industry.

### Features

Stainless steel AISI 304. Lower axis fixed. Washers and pins in marine AISI 316. Adjustable closing strength.

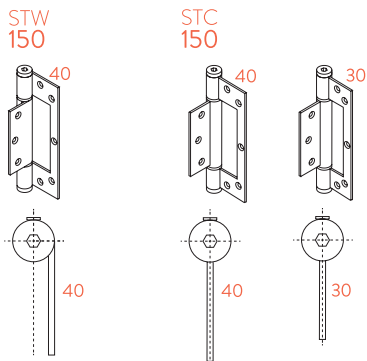





SF SF series

# SF 120

Overlapping single action hinge, specially indicated for installations in phenolic and/or similar materials.



### Uses

Doors in exhibition stands, fencing doors, call centres.

45

### Features

Available in aluminum, presented in various colors. Round edge finish. Total length of only 120mm. Load capacity up to 40kg. More than 300.000 opening and closing cycles.

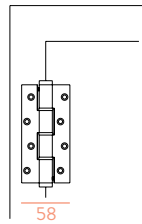
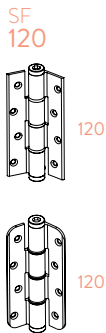

# spring hinge

**Justor**





AL

spring hinge

MB

### spring arm

## MB

Easy installable product. Possibility to easily enable or disable spring function.



### Uses

Bathroom doors, storage rooms, stores and interior doors in general.

### Features

Easy adjustable spring strength. Endurance of more than 250.000 work cycles. Aluminum finishing in various colors. Special model for outdoor installation.

MB

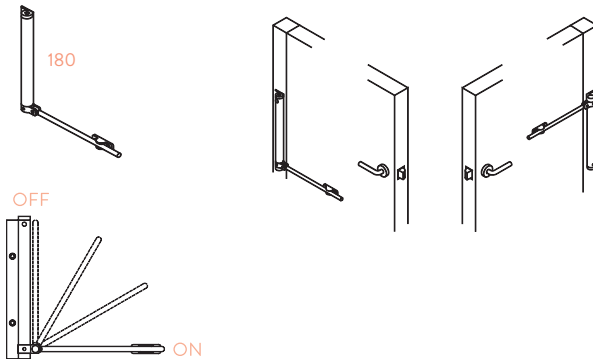







MP spring hinge

# spring hinge MP

Perfect for installation as third hinge on doors, in order to close the door automatically.



### Uses

Wardrobe doors, changing rooms, offices and others.

### Features

Complementary product on doors with already-existing hinges. Pushes doors up to 40kg. More than 200.000 work cycles. Anodized aluminum finishing and presented in blister package. To be installed at the center of the door allowing an automatic closure.

MP

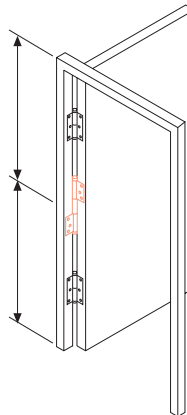
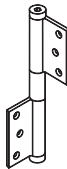

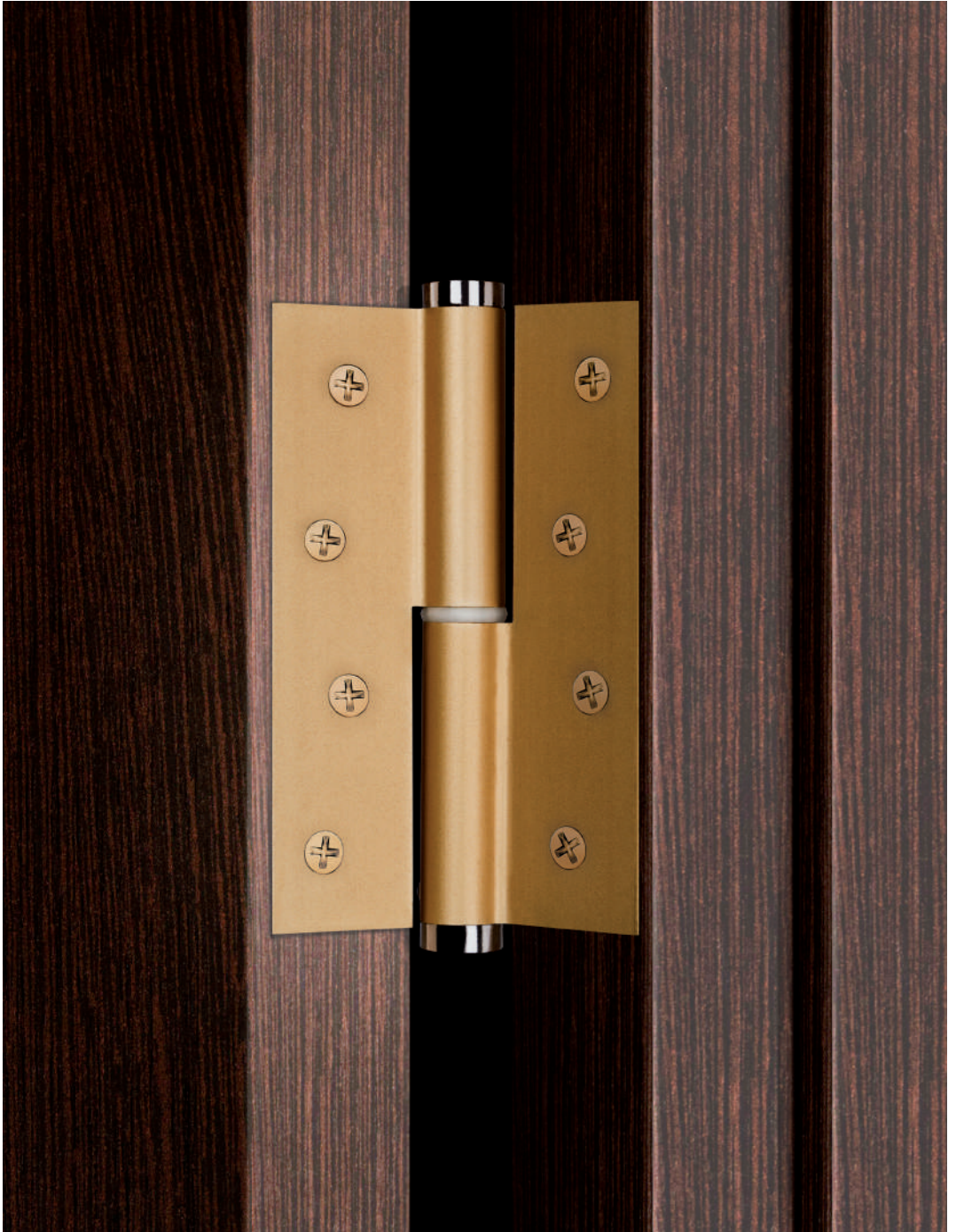



spring hinge

PM

# spring loaded paumelle PM

For wooden doors. Makes installation easier, not necessary to unscrew the hinges if removing the door is necessary at any given time.



### Uses

Cottages, apartments, hotels, schools and convention centers.

### Features

Made of aluminum exclusively for woodwork. 120mm length. For interior doors. Load capacity up to 20kg. Available in left and right models according to installation.

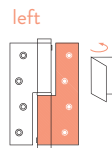
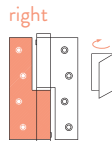
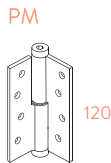

aluminum  
stainless steel

spring hinge

PF



AL

SST

PF spring hinge

## frontal paumelle

PF PF  
AL SST

Especially suitable for installations on phenolic materials or similar, this overlapping single action spring hinge allows to remove the door easily.



### Uses

Doors in public services, changing rooms, showers in campsites and sports centers.

### Features

The total length of the product is 90mm. More than 250.000 work cycles. Available in aluminum (silver finish, gold, bronze, white or black), and in AISI 304 stainless steel. Load capacity up to 25kg.

PF  
90

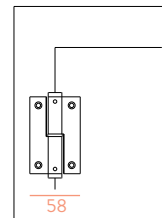
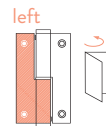
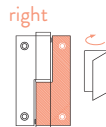



aluminum  
plastic

spring hinge

MZ AL  
MZ PL

56





AL

PLAS

PF  
spring hinge

MZ MZ  
AL PL

Screen door hinge. Ensures automatic closure of this type of auxiliary door, preventing any unwanted insects.



### Uses

Private homes, cottages, hostels.

### Features

Made of aluminum for wooden doors and high-resistance plastic for aluminum doors. The aluminum hinge comes in different color finishes, while the plastic one comes in black color. The load capacity is up to 5kg. It comes in boxes of 20 units or blister package of 2 units.

MZ

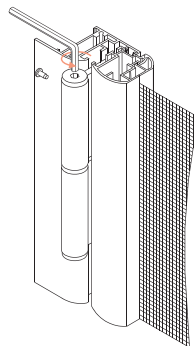
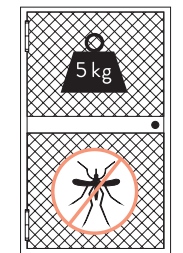
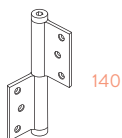

stainless steel  
iron

spring hinge

PG 120  
PG 180  
PG 240

58



IRON

SST

PG spring hinge

## Drop Hinge with washer

PG PG PG  
**120 180 240**

Hinges with washer and drop profile for installation on doors by welding. Made of steel or stainless steel. High resistance to deformation.



### Uses

Auxiliary doors, garage doors, pre-access doors of communities or heavy duty doors.

### Features

12mm drop profile. It comes in 120mm, 180mm and 240mm length. Supplied with washer. Capacity of a basic installation with two hinges ranging from 20kg to 60kg. The stainless steel version is AISI 304. Pins and washer in AISI 316.

PG  
120



120

PG  
180



180

PG  
240



240

stainless steel  
iron

spring hinge

PG 180 CR  
PG 240 CR  
PG 240 CRP

60



IRON

SST

PG spring hinge

## Drop Hinge with bearing

PG 180 CR      PG 240 CR      PG 240 CRP

Hinges with smooth opening and closing actuation due to bearing on the central axis, instead of washer, which practically doubles its capacity.



### Uses

Gate fences, furnaces, private gardens, doors of industrial lifts, exterior architecture in stainless steel.

### Features

Made of steel or stainless steel. It comes in 180mm and 240mm length. High load capacity, for doors up to 250kg in weight. Components are manufactured in stainless steel AISI 304 and AISI 316, offering high corrosion resistance.

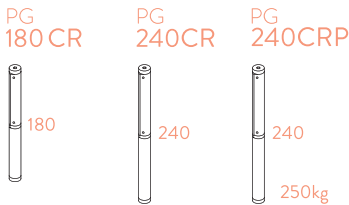

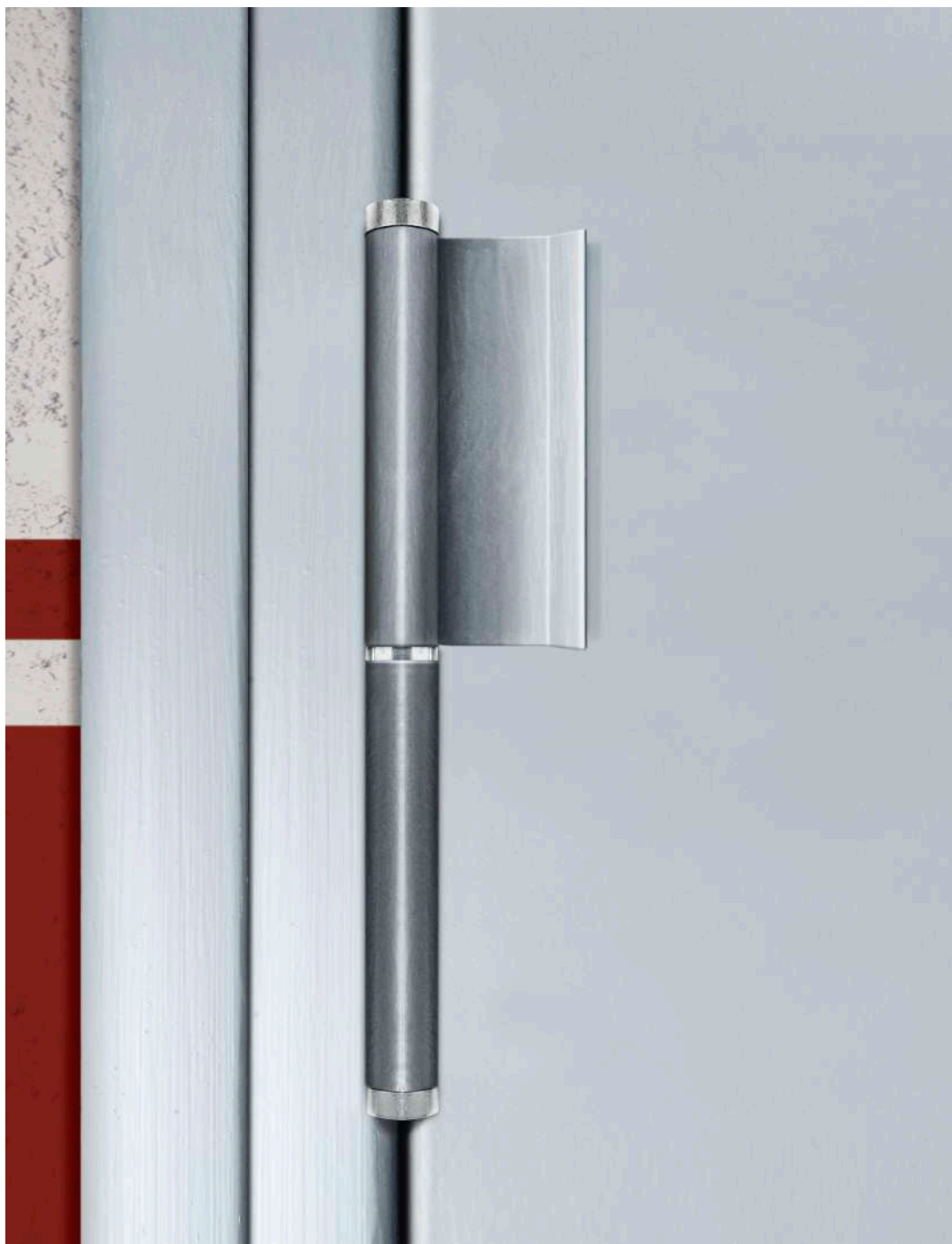

IRON

PP  
spring hinge**Blade Hinge** with washerPP  
**240**

Hinge built with 2 steel profiles. The upper pushes the door, by working on the lower washer, which is welded to the frame.

**Uses**

Warehouse doors, spray cabins, livestock accesses, fencing accesses.

**Features**

Pushes, but does not carry the weight of the door. Single length of 240mm. High resistance to deformation. 3 positions adjustable force. Opening up to 180°.

PP  
**240**



# data sheet

**Justor**

pp.

66 overview

68 DA / DP

70 SA / ST / SF

72 MB / MP / PM / PF / MZ

73 PG / PP

	HINGES FAMILIES	IRON DA/SA PG/PP	ALUMINUM DA/DP/SA/ST/SF MB/MP/PM/PF*/MZ
OUTSIDE	blade	steel	aluminum
	treatment	galvanized	anodized (10u-15u)
	adjustable cap	sintered carbon steel	chromed zamac (*PF polyamide 6+6)
	pins	steel galvanized	steel galvanized
	washers	sintered carbon steel	polyamide
INSIDE	inner axle	stainless steel AISI 304	stainless steel AISI 304
	inner spring	carbon steel sheets set	carbon steel sheets set
	spring protection grease	synthetic lytic temp. -45°C to 125C°	synthetic lytic temp. -45°C to 125C°
PERFORMANCE	application	suitable for indoor/ outdoor installation	suitable for indoor/ outdoor installation
	automatic return	yes	yes
	adjustable return power	yes	yes (*PF no)
	maximum door opening	180°	180°

SST AISI 304 DA/SA/ST PF*/PG/PP	SST AISI 316 DA/SA	PLASTIC MZ
stainless steel AISI 304	stainless steel AISI 316	polyamide 6+6 fiberglass
polished	polished	-
sintered AISI 316	sintered AISI 316	polyamide 6+6 fiberglass
stainless steel AISI 304	stainless steel AISI 304	electrophoretic deposition steel
stainless steel AISI 316	stainless steel AISI 316	-
stainless steel AISI 304	stainless steel AISI 316	polyamide 6+6 fiberglass
stainless steel sheets AISI set 301	stainless steel sheets AISI set 301	stainless steel sheets AISI set 301
synthetic lytic temp. -45°C to 125C°	synthetic lytic temp. -45°C to 125C°	synthetic lytic temp. -45°C to 125C°
suitable for indoor/ outdoor installation	suitable for indoor/ outdoor installation	suitable for indoor/ outdoor installation
yes	yes	yes
yes (*PF no)	yes	yes
180°	180°	180°

# DA / DP double action

for swing doors

68

## DA E al 180

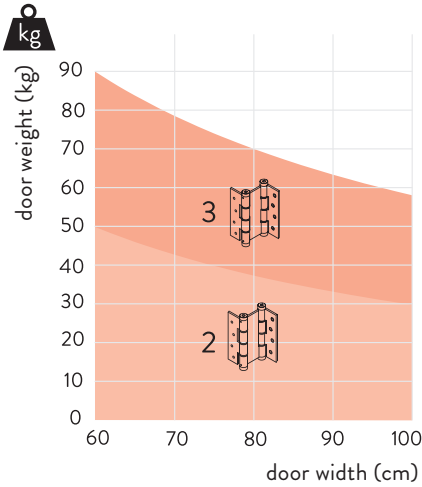
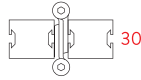

## DA al 180 DA sst 180 DA iron 180

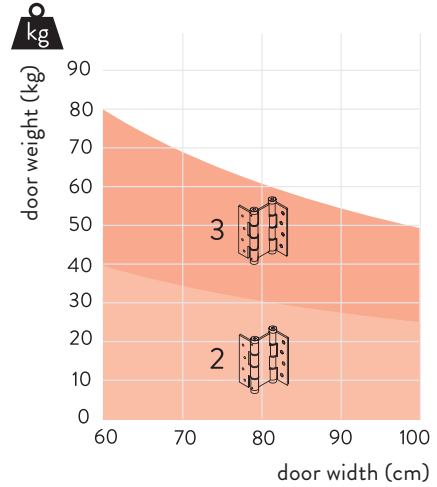
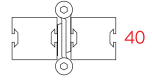

## DAW al 180

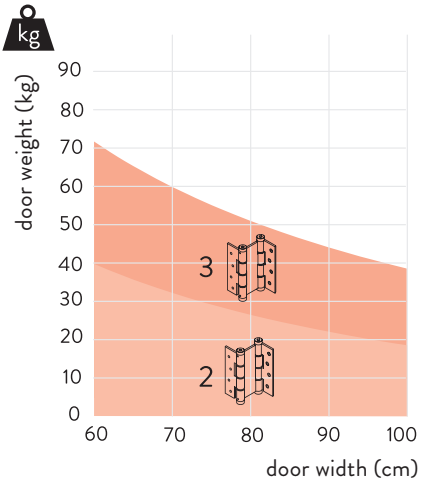
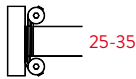

## DA R40 al 180 DA A al 180

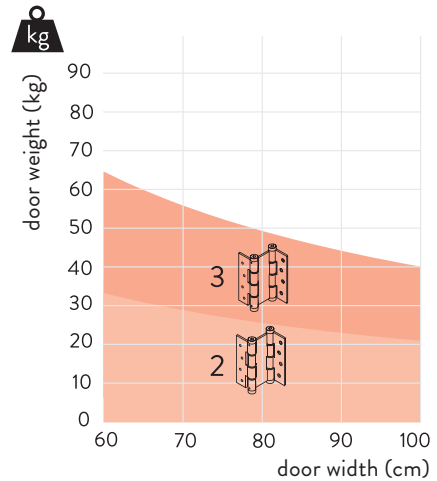
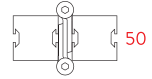

assembly  
video DA



DA E al 120  
DAW A al 180

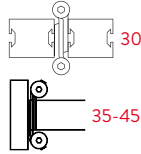

DA al 120  
DAW al 120  
DA sst 120  
DA iron 120

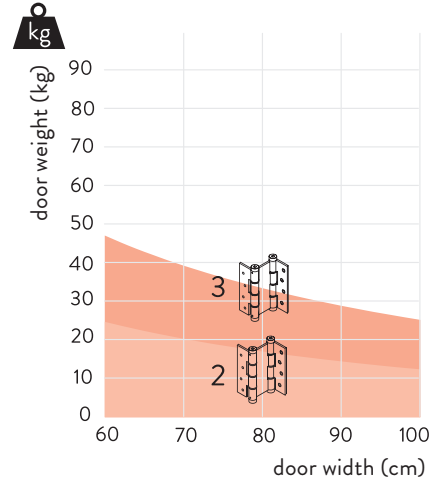
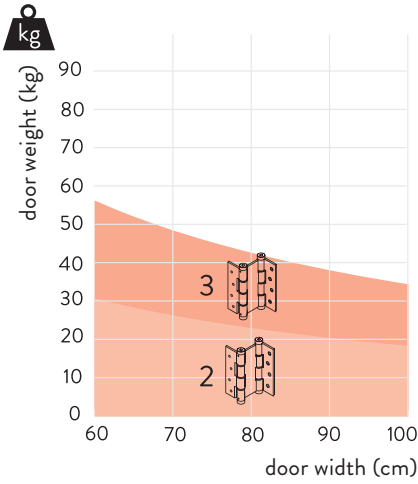
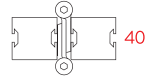

DP al 120

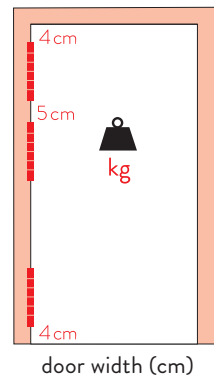
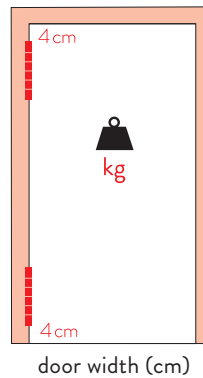
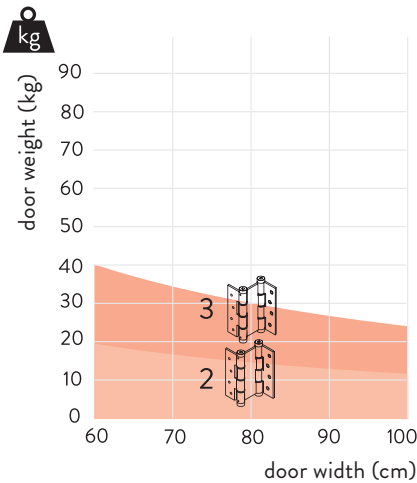



# SA / ST / SF single action

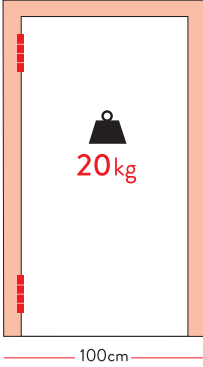

SA al 120  
SA sst 120  
SA iron 120

installation  
2 hinges

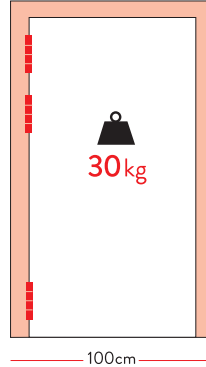

SA al 120  
SA sst 120  
SA iron 120

installation  
3 hinges

70

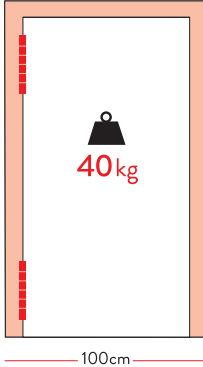

SA al 180  
SA sst 180  
SA iron 180

installation  
2 hinges

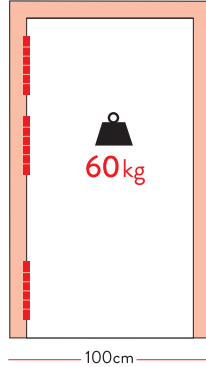

SA al 180  
SA sst 180  
SA iron 180

installation  
3 hinges

**aluminium**

∅16



**sst 120**

∅17



**sst 180**

∅18



**iron 120**

∅17



**iron 180**

∅18



assembly  
video ST



**STW al 150**  
**STC al 150**

installation  
2 hinges

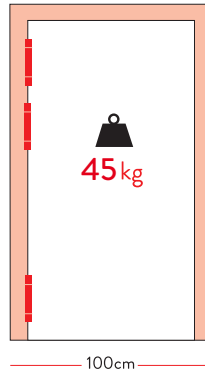

**STW al 150**  
**STC al 150**

installation  
3 hinges

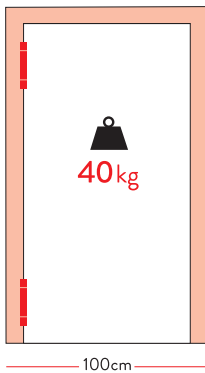

**STW sst 150**  
**STC sst 150**

installation  
2 hinges

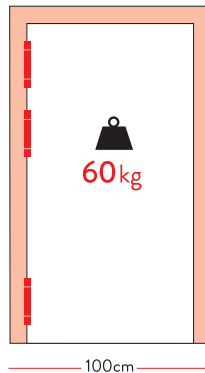

**STW sst 150**  
**STC sst 150**

installation  
3 hinges



**SF al 120**

installation  
2 hinges

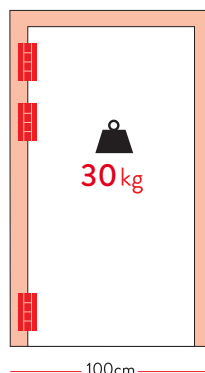

**SF al 120**

installation  
3 hinges



# MB/MP/PM/PF/MZ spring hinge

assembly  
video MB

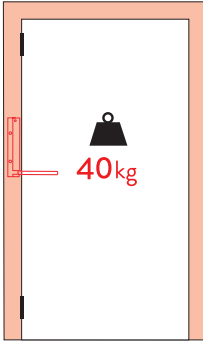

**MB al**

installation  
1 hinge

ø16



85 cm

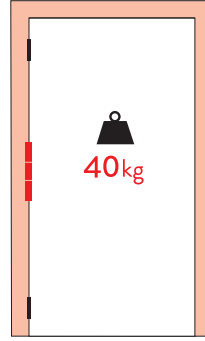

**MP al**

installation  
1 hinge

ø16



85 cm

72

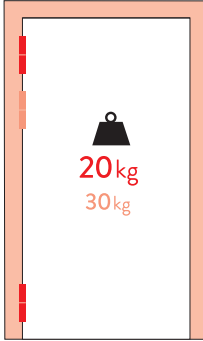

**PM al**

installation  
2 hinges

installation  
3 hinges

ø16



100cm

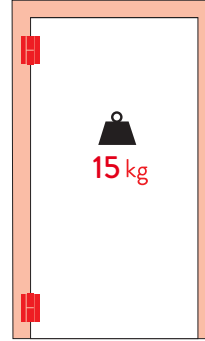

**PF al 90**

installation  
2 hinges

ø16



100cm

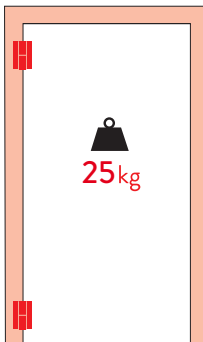

**PF sst 90**

installation  
2 hinges

ø17



100cm

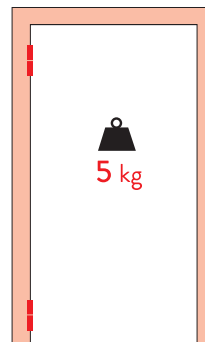

**MZ al  
MZ plastic**

installation  
2 hinges

ø17



100cm

# PG/PP spring hinge



**PG 120 sst**  
**PG 120 iron**  
installation  
2 hinges

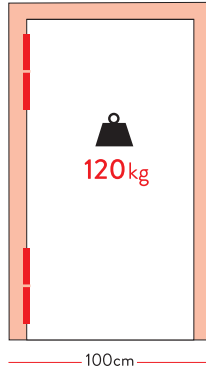

**PG 240 CR sst**  
**PG 240 CR iron**  
installation  
2 hinges

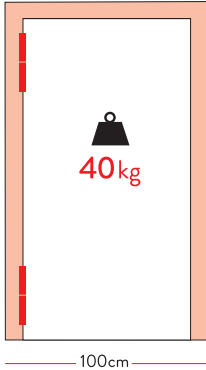
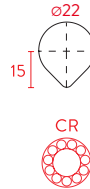

**PG 180 sst**  
**PG 180 iron**  
installation  
2 hinges

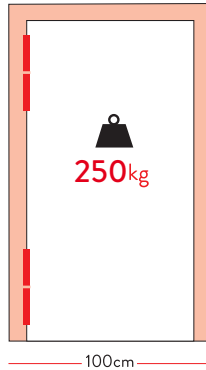

**PG 240 CRP sst**  
**PG 240 CRP iron**  
installation  
2 hinges

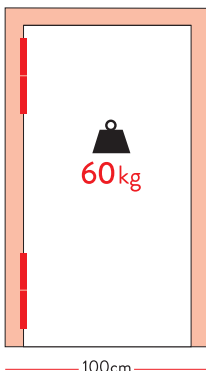
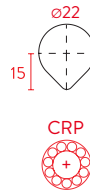

**PG 240 sst**  
**PG 240 iron**  
**PG 180 CR sst**  
**PG 180 CR iron**  
installation  
2 hinges

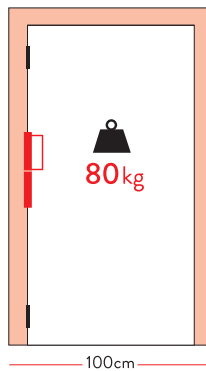
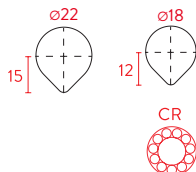

**PP 240 iron**  
installation  
1 hinge

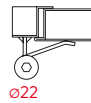

codes

codes

**Justor**





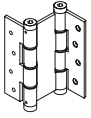

### Double action hinge DA 120

Packaging: 15 units box /  
20 units blister

			Box (x2)	Blister (x1)
<b>DA 120</b>	<b>DA 120</b>	Silver	5414.01	5413.01
		Gold	5414.02	5413.02
		Bronze	5414.03	5413.03
		Gold brass	5414.04	5413.04
		White	5414.06	5413.06
		Black	5414.09	5413.09
		F6	5414.94	5413.94
		Special	5414.99	5413.99
	SST	5414.05	5413.05	
	SST 316	5414.35	5413.35	

Iron zinc-plated 5414.08 -

<b>DA 120 R</b>	<b>DA 120 R</b>	Silver	5414.21	5413.21
		Gold	5414.22	5413.22
		Bronze	5414.23	5413.23
		Gold brass	5414.24	5413.24
		White	5414.26	5413.26
		Black	5414.29	5413.29



SST 5414.25 5413.25

<b>DA 120 Narrow</b>	<b>DA 120 Narrow</b>	Silver	5404.01	5403.01
		Gold	5404.02	5403.02
		Bronze	5404.03	5403.03
		Gold brass	5404.04	5403.04
		White	5404.06	5403.06
		Black	5404.09	5403.09
		F6	5404.94	5403.94
Special	5404.99	5403.99		



<b>DA 120 R Narrow</b>	<b>DA 120 R Narrow</b>	Silver	5404.21	5403.21
		Gold	5404.22	5403.22
		Bronze	5404.23	5403.23
		Gold brass	5404.24	5403.24
		White	5404.26	5403.26
		Black	5404.29	5403.29

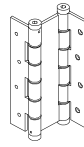

### Double action hinge DA 180

Packaging: 15 units box /  
20 units blister

			Box (x2)	Blister (x1)
<b>DA 180</b>	<b>DA 180</b>	Silver	5914.01	5913.01
		Gold	5914.02	5913.02
		Bronze	5914.03	5913.03
		Gold brass	5914.04	5913.04
		White	5914.06	5913.06
		Black	5914.09	5913.09
		F6	5914.94	5913.94
		Special	5914.99	5913.99
	SST	5914.05	5913.05	
	SST 316	5914.35	5913.35	

Iron zinc-plated 5914.08 -

<b>DA 180 R</b>	<b>DA 180 R</b>	Silver	5914.21	5913.21
		Gold	5914.22	5913.22
		Bronze	5914.23	5913.23
		Gold brass	5914.24	5913.24
		White	5914.26	5913.26
		Black	5914.29	5913.29



SST 5914.25 5913.25

<b>DA 180 Narrow</b>	<b>DA 180 Narrow</b>	Silver	5904.01	5903.01
		Gold	5904.02	5903.02
		Bronze	5904.03	5903.03
		Gold brass	5904.04	5903.04
		White	5904.06	5903.06
		Black	5904.09	5903.09
		Special	5904.94	5903.94



<b>DA 180 R Narrow</b>	<b>DA 180 R Narrow</b>	Silver	5904.21	5903.21
		Gold	5904.22	5903.22
		Bronze	5904.23	5903.23
		Gold brass	5904.24	5903.24
		White	5904.26	5903.26
		Black	5904.29	5903.29



<b>DA 180 Wide</b>	<b>DA 180 Wide</b>	Silver	5934.01	-
		Gold	5934.02	-
		Bronze	5934.03	-
		Gold brass	5934.04	-
		White	5934.06	-
		Black	5934.09	-
Special	5934.94	-		



<b>DA 180 R Wide</b>	<b>DA 180 R Wide</b>	Silver	5934.21	-
		Gold	5934.22	-
		Bronze	5934.23	-
		Gold brass	5934.24	-
		White	5934.26	-
		Black	5934.29	-



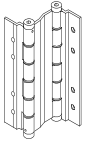

### Double action hinge DA R40

Packaging: 15 units box

		Box (x2)		Blister
<b>DA R40</b>	<b>DA R40</b>	Silver	R- 5934.01	-
		Gold	R- 5934.02	-
		Bronze	R- 5934.03	-
		Gold brass	R- 5934.04	-
		White	R- 5934.06	-
		Black	R- 5934.09	-
		Special	R- 5934.99	-

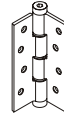

### Single action hinge SA 120

Packaging: 20 units box / 25 units blister

		Box (x2)		Blister (x1)
<b>SA 120</b>	<b>SA 120</b>	Silver	5314.01	5313.01
		Gold	5314.02	5313.02
		Bronze	5314.03	5313.03
		Gold brass	5314.04	5313.04
		White	5314.06	5313.06
		Black	5314.09	5313.09
		F6	5314.94	5313.94
		Special	5314.99	5313.99
		SST	5314.05	5313.05
		SST 316	5314.35	5313.35

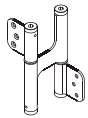

### Double action hinge DP 120

Packaging: 15 units box / 20 units blister

		Box (x2)		Blister (x1)
<b>DP 120</b>	<b>DP 120</b>	Silver	6014.01	6013.01
		Gold	6014.02	6013.02
		Bronze	6014.03	6013.03
		Gold brass	6014.04	6013.04
		White	6014.06	6013.06
		Black	6014.09	6013.09
		Special	6014.99	6013.99

Iron zinc-plated 5314.08 -

		Box (x2)		Blister (x1)
<b>SA 120 R</b>	<b>SA 120 R</b>	Silver	5314.21	5313.21
		Gold	5314.22	5313.22
		Bronze	5314.23	5313.23
		Gold brass	5314.24	5313.24
		White	5314.26	5313.26
		Black	5314.29	5313.29



SST 5314.25 5313.25

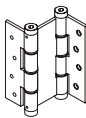

### Double action hinge DAW

Packaging: 15 units box / 20 units blister

		Box (x2)		Blister (x1)
<b>DA W</b>	<b>DA W</b>	Silver	6414.01	6413.01
		Gold	6414.02	6413.02
		Bronze	6414.03	6413.03
		Gold brass	6414.04	6413.04
		White	6414.06	6413.06
		Black	6414.09	6413.09
		Special	6414.99	6413.99

		Box (x2)		Blister (x1)
<b>DA W</b>	<b>DA W</b>	Silver	6914.01	6913.01
		Gold	6914.02	6913.02
		Bronze	6914.03	6913.03
		Gold brass	6914.04	6913.04
		White	6914.06	6913.06
		Black	6914.09	6913.09

		Box (x2)		Blister (x1)
<b>DA W</b>	<b>DA W</b>	Silver	6934.01	-
		Gold	6934.02	-
		Bronze	6934.03	-
		Gold brass	6934.04	-
		White	6934.06	-
		Black	6934.09	-

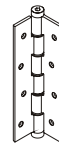

### Single action hinge SA 180

Packaging: 20 units box / 25 units blister

		Box (x2)		Blister (x1)
<b>SA 180</b>	<b>SA 180</b>	Silver	5814.01	5313.01
		Gold	5814.02	5313.02
		Bronze	5814.03	5313.03
		Gold brass	5814.04	5313.04
		White	5814.06	5313.06
		Black	5814.09	5313.09
		F6	5814.94	5313.94
		Special	5814.99	5313.99

SST 5814.05 5313.05  
SST 316 5814.35 5313.35

Iron zinc-plated 5814.08 -

		Box (x2)		Blister (x1)
<b>SA 180 R</b>	<b>SA 180 R</b>	Silver	5314.21	5313.21
		Gold	5314.22	5313.22
		Bronze	5314.23	5313.23
		Gold brass	5314.24	5313.24
		White	5314.26	5313.26
		Black	5314.29	5313.29



SST 5314.25 5313.25

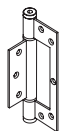

### Single action hinge STC

Packaging: 20 units box /  
25 units blister

			Box (x2)	Blister (x1)	
<b>STC 150</b>	<b>STC 150</b>	Silver	6364.01	6363.01	
		Gold	6364.02	6363.02	
		Bronze	6364.03	6363.03	
		Gold brass	6364.04	6363.04	
		White	6364.06	6363.06	
		Black	6364.09	6363.09	
		Special	6364.99	6363.99	
		SST	6364.05	6363.05	
	<b>Narrow</b>		Silver	6354.01	6353.01
			Gold	6354.02	6353.02
Bronze			6354.03	6353.03	
Gold brass			6354.04	6353.04	
White			6354.06	6353.06	
Black			6354.09	6353.09	
Special			6354.99	6353.99	
SST	6354.05	6353.05			

78



### Single action hinge STW

Packaging: 20 units box /  
25 units blister

			Box (x2)	Blister (x1)
<b>STW 150</b>	<b>STW 150</b>	Silver	6314.01	6313.01
		Gold	6314.02	6313.02
		Bronze	6314.03	6313.03
		Gold brass	6314.04	6313.04
		White	6314.06	6313.06
		Black	6314.09	6313.09
		Special	6314.99	6313.99
		SST	6314.05	6313.05

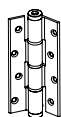

### Single action hinge SF

Packaging: 20 units box /  
25 units blister

			Box (x2)	Blister (x1)
<b>SF 120</b>	<b>SF 120</b>	Silver	5114.01	5113.01
		Gold	5114.02	5113.02
		Bronze	5114.03	5113.03
		Gold brass	5114.04	5113.04
		White	5114.06	5113.06
		Black	5114.09	5113.09
		Special	5114.99	5113.99

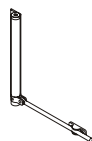

### Spring arm MB

Packaging: 25 units blister

			Box	Blister (x1)
<b>MB</b>	<b>MB</b>	Silver	-	5613.01
		Gold	-	5613.02
		Bronze	-	5613.03
		White	-	5613.06
		Black	-	5613.09
		Special	-	5613.99
		Exterior (Black)	-	5613.85

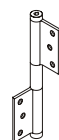

### Spring hinge MP

Packaging: 25 units blister

			Box	Blister (x1)
<b>MP</b>	<b>MP</b>	Silver	-	5713.01
		Gold	-	5713.02
		Bronze	-	5713.03
		Gold brass	-	5713.04
		White	-	5713.06
		Black	-	5713.09
		F6	-	5713.94
		Special	-	5713.99

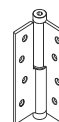

### Spring hinge PM 120

Packaging: 20 units box /  
25 units blister

			Box (x2)	Blister (x1)
<b>PM 120 Left</b>	<b>PM 120 Left</b>	Silver	5244.01	5243.01
		Gold	5244.02	5243.02
		Bronze	5244.03	5243.03
		Gold brass	5244.04	5243.04
		White	5244.06	5243.06
		Black	5244.09	5243.09
		Special	5244.99	5243.99
<b>PM 120 Right</b>	<b>PM 120 Right</b>	Silver	5254.01	5253.01
		Gold	5254.02	5253.02
		Bronze	5254.03	5253.03
		Gold brass	5254.04	5253.04
		White	5254.06	5253.06
		Black	5254.09	5253.09
		Special	5254.99	5253.99

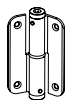

### Frontal paumelle PF 90

Packaging: 20 units box /  
25 units blister

			Box (x2)	Blister
<b>PF 90</b>	<b>PF 90</b> <b>Left</b>	Silver	5044.01	-
		Gold	5044.02	-
		Bronze	5044.03	-
		Gold brass	5044.04	-
		White	5044.06	-
		Black	5044.09	-
		Special	5044.99	-
		SST	5044.05	-
<b>PF 90</b> <b>Right</b>		Silver	5054.01	-
		Gold	5054.02	-
		Bronze	5054.03	-
		Gold brass	5054.04	-
		White	5054.06	-
		Black	5054.09	-
		Special	5054.99	-
		SST	5054.05	-

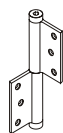

### Spring hinge MZ

Packaging: 25 units blister

			Box (x20)	Blister (x2)
<b>MZ</b>	<b>MZ</b> <b>al</b>	Silver	6719.01	6717.01
		Gold	6719.02	6717.02
		Bronze	6719.03	6717.03
		White	6719.06	6717.06
		Black	6719.09	6717.09
<b>MZ</b> <b>plastic</b>	Black	I-6710	I-6717	



### Drop spring hinge for welding PG

			Box (x2)	Box (x20)
<b>PG</b> <b>120</b>	<b>PG</b> <b>SST</b>	SST	I-5524.05	I-5529.05
		Iron	I-5524	I-5529
		Iron zinc-plated	I-5524.08	I-5529.08
<i>Box (x15)</i>				
<b>PG</b> <b>180</b>	<b>PG</b> <b>SST</b>	SST	I-5324.05	I-5325.05
		Iron	I-5324	I-5325
		Iron zinc-plated	I-5324.08	I-5325.08
<i>Box (x12)</i>				
<b>PG</b> <b>240</b>	<b>PG</b> <b>SST</b>	SST	I-5124.05	I-5126.05
		Iron	I-5124	I-5126
		Iron zinc-plated	I-5124.08	I-5126.08
<i>Box (x15)</i>				

<b>PGCR</b> <b>180</b> <b>CR</b>	<b>PG</b> <b>SST</b>	SST	I-5334.05	I-5335.05
		Iron	I-5334	I-5335
		Iron zinc-plated	I-5334.08	I-5335.08
<i>Box (x12)</i>				
<b>PG</b> <b>240</b> <b>CR</b>	<b>PG</b> <b>SST</b>	SST	I-5134.05	I-5136.05
		Iron	I-5134	I-5136
		Iron zinc-plated	I-5134.08	I-5136.08
<i>Box (x12)</i>				
<b>PG</b> <b>240</b> <b>CRP</b>	<b>PG</b> <b>SST</b>	SST	I-5144.05	I-5146.05
		Iron	I-5144	I-5146
		Iron zinc-plated	I-5144.08	I-5146.08



### Blade spring hinge for welding PP

			Box (x2)	Box (x12)
<b>PP</b> <b>240</b>	<b>PP</b> <b>Iron</b>	Iron	I-5224	I-5226
		Iron zinc-plated	I-5224.08	I-5226.08

If you wish to know more about Justor products, have a look at the **general catalogue of Talleres Trepát S.A.** and discover other solutions and our **Blue Line**.

You can also visit our online page [www.justor.com](http://www.justor.com).

## Our products

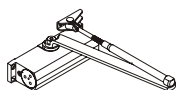

**Door closers.** Available with arm set. Ready to resist frequent and/or intensive usage, on doors up to 120kg.

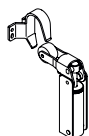

**Retaining brakes.** They prevent doors from slamming and ensure the total and silent closing of the door.

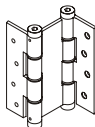

**Hinges.** Always with a laminated spring set inside, for all types of doors, from screen doors of only 5kg to swing doors of 60kg and iron doors of 250kg.

## Blue Line

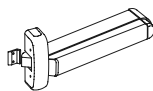

**Antipanic.** 100% reversible. Certified to be installed on fire doors.



**Pin door.** Sliding and sliding flush bolts for all types of doors and windows.

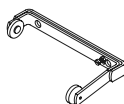

**Complements.** Complementary products for doors and windows. Addressed to the professional field of aluminium and wood.



[www.justor.com](http://www.justor.com)

**Justor**

The photographs, images, contents and products presented in this catalogue are of illustrative and orientative character, therefore they will not generate any right or expectation of right, nor are they a binding commercial offer, being they protected by intellectual and industrial property rights in favour of Talleres Trepat S.A.